

2

1

B

B

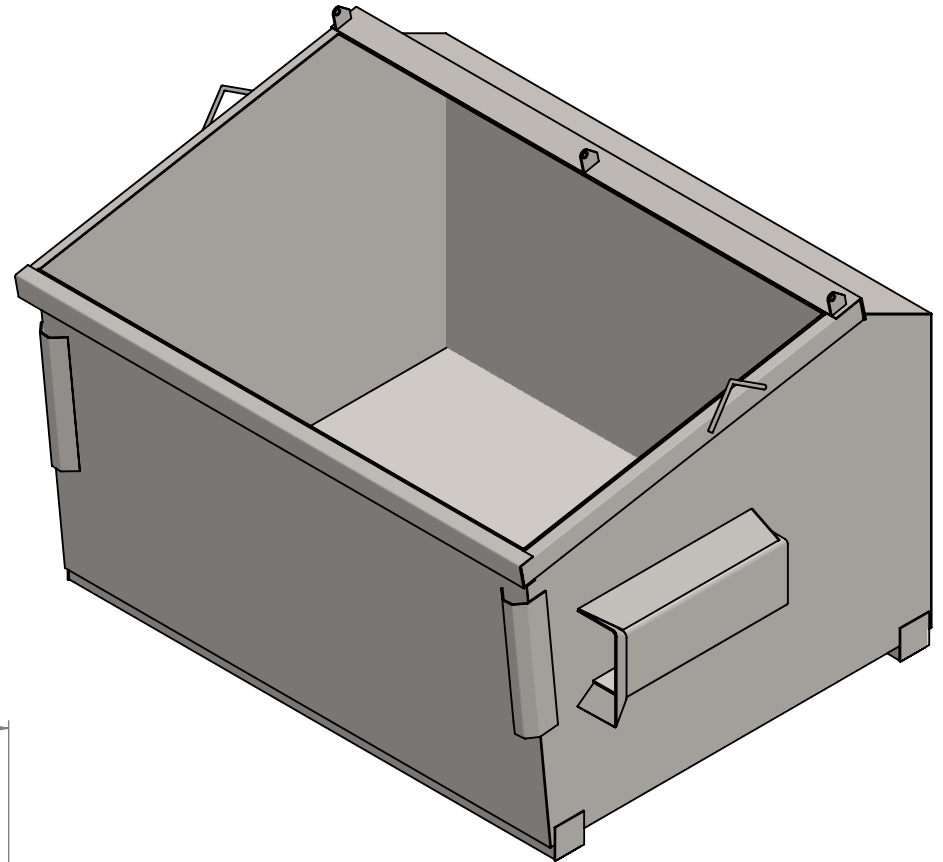
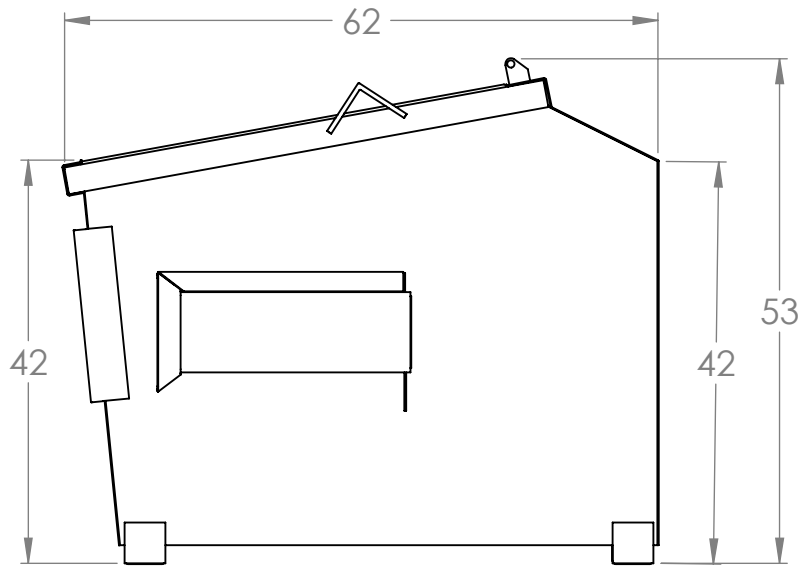

A

A

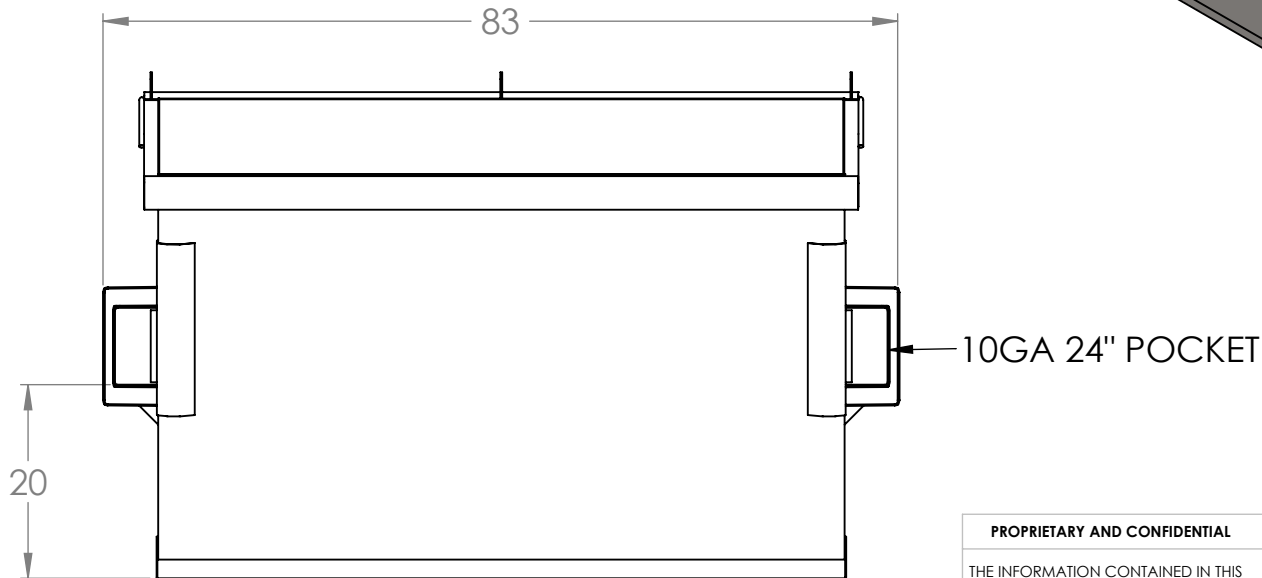

2

1

POYNETTE IRONWORKS

PROPRIETARY AND CONFIDENTIAL

THE INFORMATION CONTAINED IN THIS DRAWING IS THE SOLE PROPERTY OF POYNETTE IRONWORKS. ANY REPRODUCTION IN PART OR AS A WHOLE WITHOUT THE WRITTEN PERMISSION OF POYNETTE IRONWORKS IS PROHIBITED.

UNLESS OTHERWISE SPECIFIED:		TITLE:	
DIMENSIONS ARE IN INCHES		PART NO:	
TOLERANCES:		4 FLLP-2 LID	
FRACTIONAL	±1/2	SIZE	DESIGNED BY:
WEIGHT	±5%	A	DATE:
MATERIAL			3/23/2020
		SCALE:	1:20 WEIGHT: 630
			REV -
			SHEET 1 OF 1